

Cooper

Cooper Elevators™

.. a brand with finest designs & impeccable installations !

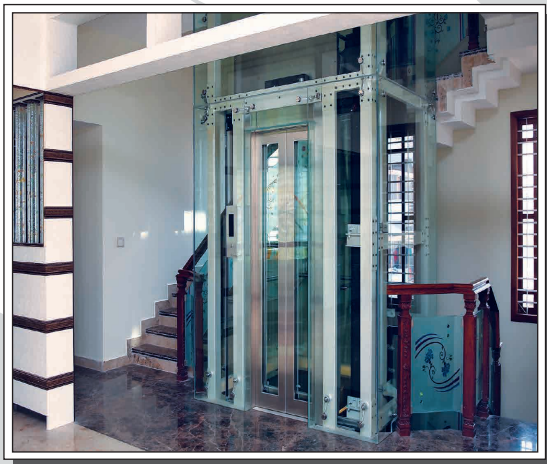
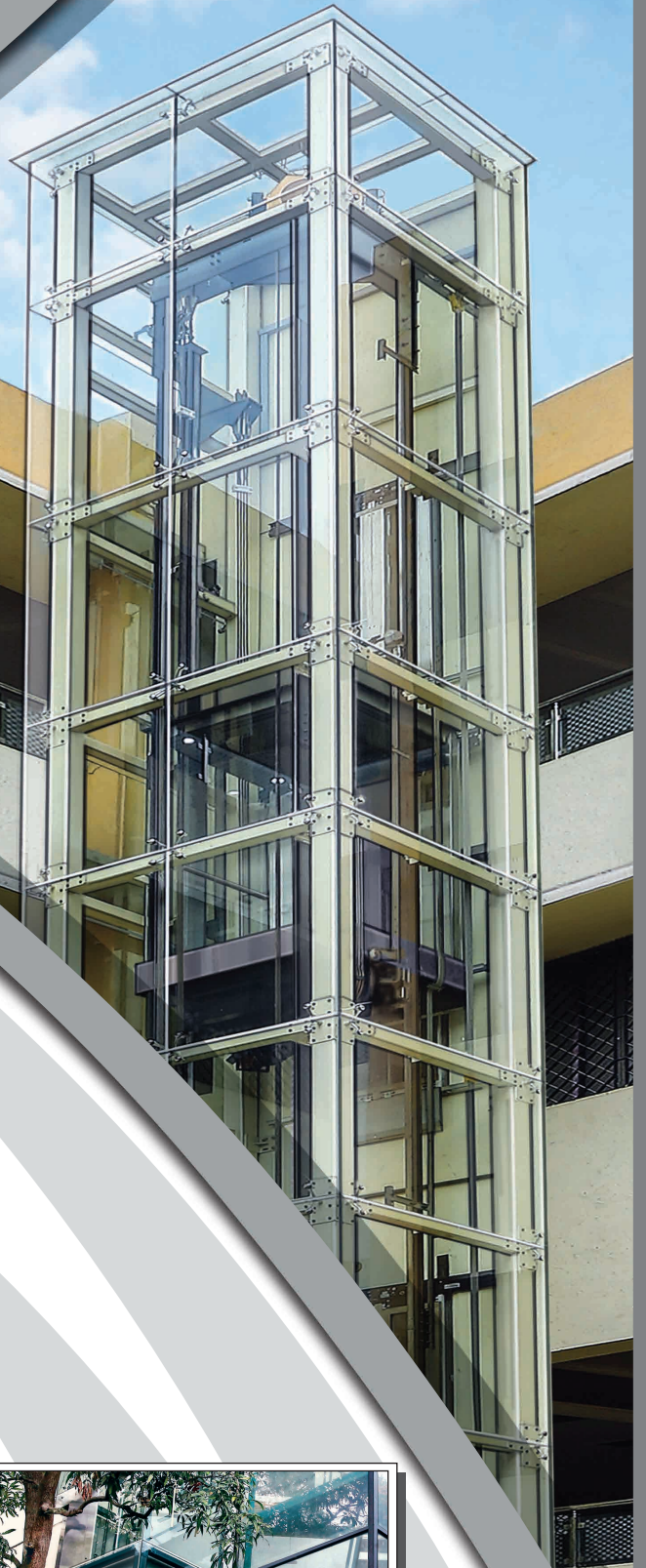

ADVANCED MACHINE ROOM LESS ELEVATOR:

- Reduced space for components leaving usable building area
- Suitable for Mid-High Rise buildings upto 60 meters height
- Energy-efficient, Hassle-free & Easy Maintenance
- High speed capability upto 2 meters per second

Cooper Elevators™

With best-in-industry ride-quality, safety and durability through the best in international technology and engineering, Cooper Elevators is your natural partner of choice for the finest designs & impeccable installations.

With over a decade of quality experience in manufacturing, installation and commissioning of world-class elevators, the company is Head Quartered in Chennai with operations in Bengaluru, Vijayawada, Coimbatore & Trichy with expansion into Pune, Mysore & Hyderabad on the cards in the near future.

Cooper Elevators' strong in-house fabrication and assembly facilities include state-of-the-art infrastructure and high quality design facilities.

Our 12,000 sqft facility seamlessly integrates manufacturing, R & D and warehouse under one roof.

With rock solid credibility built over thousands of high quality installations for prestigious clients, Cooper Elevators offers an unmatched range of products, accessories and 1 year of free maintenance on every installation.

Our USP is Quality, Delivery & Service.

Whatever the size, application or technical constraints in your project, Cooper Elevators has the perfect solution for you !

SOME OF OUR IMPRESSED CUSTOMERS

Ceebros, S & S Foundation, K. G. Foundation, Russel Foundation, AKM Rigid Developer, Vishwakarma, Harmony Homes, Harini Builders, C. R. Raju Architects, P. S. P. Architects, M.G.R. University, Absolute Barbeque, Adyar Ananda Bahwan, Tanishq, Rasi Silks ...to mention a few.

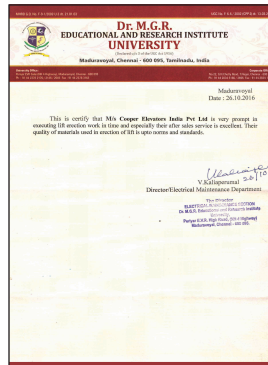
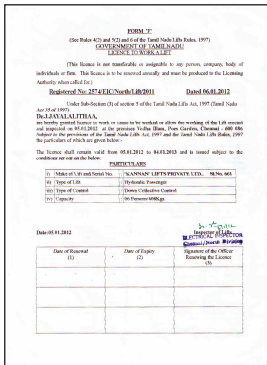

An Architect-way

A visual treat & an awe-inspired experience !



The ideal choice - While Dr. M.G.R. Educational and Research Institute continues to provide solutions to 21st century problems through education and technology, Cooper Elevators is proud to have customized its high quality, world-class, feature-laden elevators to add value to the infrastructure of the institution.

The elevators installed in the campus are testimony to the fact that Cooper elevators are an ideal choice for mid high-rise projects. The installation takes the image of the building to an unimaginable level in terms of appearance, convenience and performance.

MRL Lift machine fixed on the guide rails,
All static & Dynamic loads will be transferred to the pit



Designed to inspire

Contemporary designs and new age technology have been the top-notch priorities when Cooper Elevators set out to create the blue print for the elevator system for the institution's campus at Dr. M.G.R. Educational and Research Institute. Cooper has successfully added value to the infrastructure by installing advance machine room less elevators (MRL), saving a lot of space for other components.

Lifts without machine room are one of the most applauded improvements in the elevator manufacturing sectors. The elevator installations inside this institution are not only a visual treat to look at but also leave the user with an awe-inspired experience.



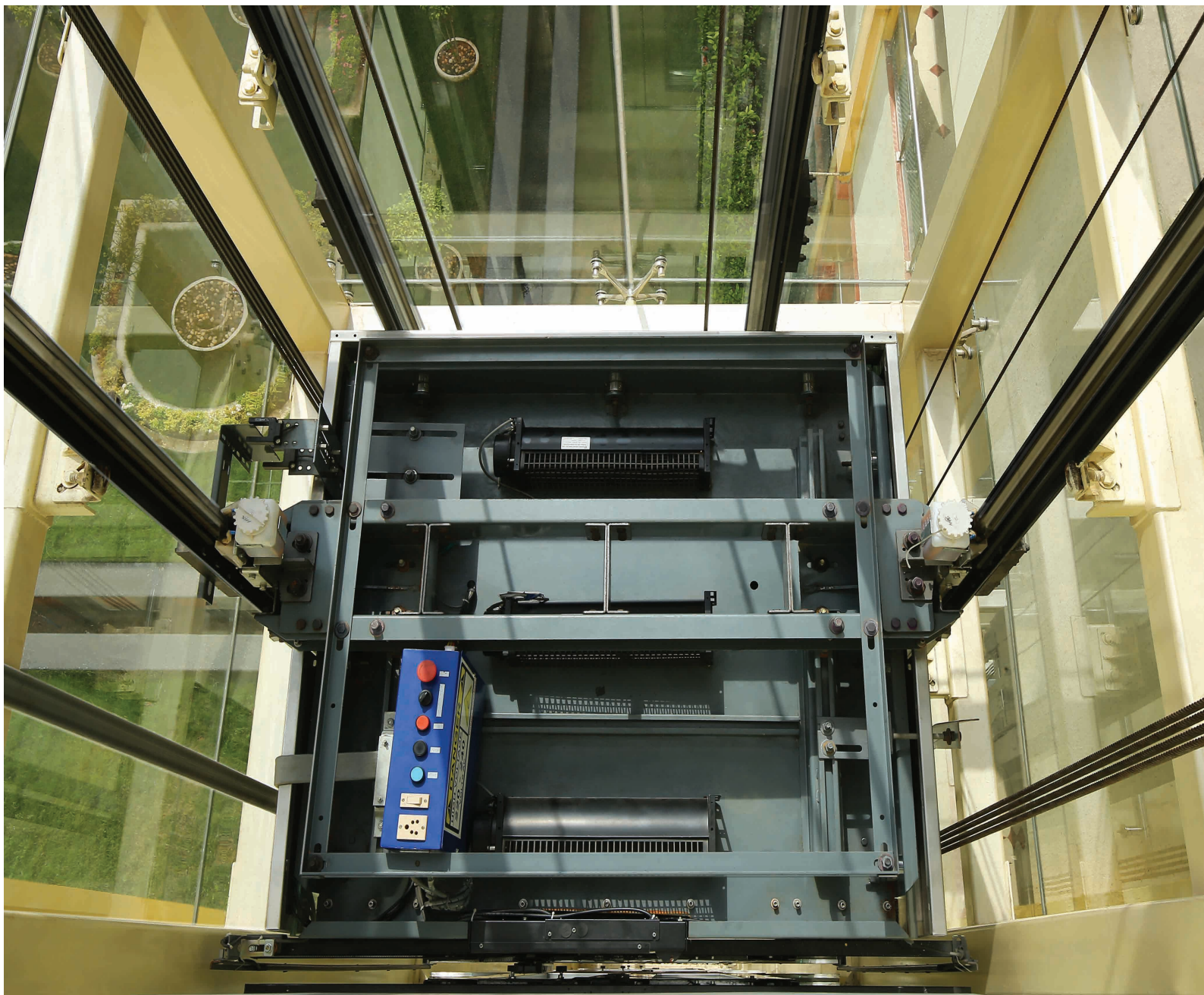

Saving Energy

Imagine having an elevator system which consumes a significant amount of the electricity supplied to your building and premises? It would definitely not be a sustainable choice in the long run. Cooper Elevators always ensures to keep this concern of the end consumer in mind while designing its contemporary products.

That is why, we have designed an elevator system for the institution that is not only energy efficient, but also provides easy and hassle-free maintenance service.



Lift Dimension

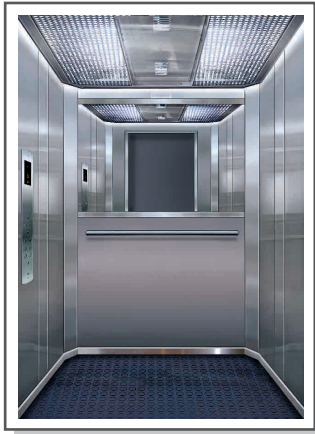

4 Passenger (272 Kg) Cabin Size					
No	Car Width	Car Depth	Well Width	Well Depth	Door Opening
1	1100	700	1750	1300	700/800
2	950	850	1400	1500	700



5 Passenger (340 Kg) Cabin Size					
No	Car Width	Car Depth	Well Width	Well Depth	Door Opening
1	1000	1000	1600	1400	700
2	1200	800	2000	1300	700/800
3	800	1200	1500	2000	700
4	1100	900	1800	1500	700/800

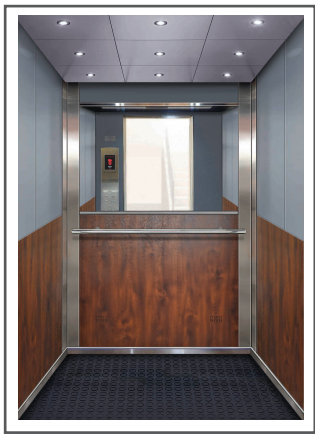

6 Passenger (408 Kg) Cabin Size					
No	Car Width	Car Depth	Well Width	Well Depth	Door Opening
1	1100	1000	1800	1600	700/800
2	1000	1100	1700	1800	700
3	1200	900	1800	1500	700/800
4	900	1200	1600	1800	700

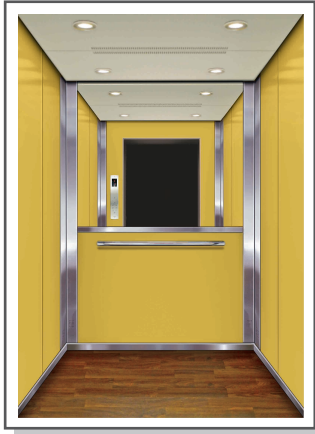

8 Passenger (544 Kg) Cabin Size					
No	Car Width	Car Depth	Well Width	Well Depth	Door Opening
1	1300	1100	1800	1600	700/800
2	1100	1300	1700	1900	700
3	1200	1200	1800	1800	700/800
4	1400	1000	2000	1600	700/800
5	1000	1400	1750	2000	700

10 Passenger (680 Kg) Cabin Size					
No	Car Width	Car Depth	Well Width	Well Depth	Door Opening
1	1500	1300	2100	1900	800/900
2	1300	1500	2000	2100	800/900
3	1400	1300	2000	2000	800/900
4	1300	1400	1900	2000	700/800

Performance and Perfection:

Cooper Elevators flaunts a stunning range of designer cabins that you can choose from, as has been installed at Dr. M.G.R. Educational and Research Institute. The optional glass cladding ambience boosts the appearance of the elevator system.

Cooper Elevators design systems with high speed capability of 3 m/s keeping pace with the rush-hours of everyone's lives.



Optimized Space & Energy

a high-quality gearless lift in the lap of luxury designs !

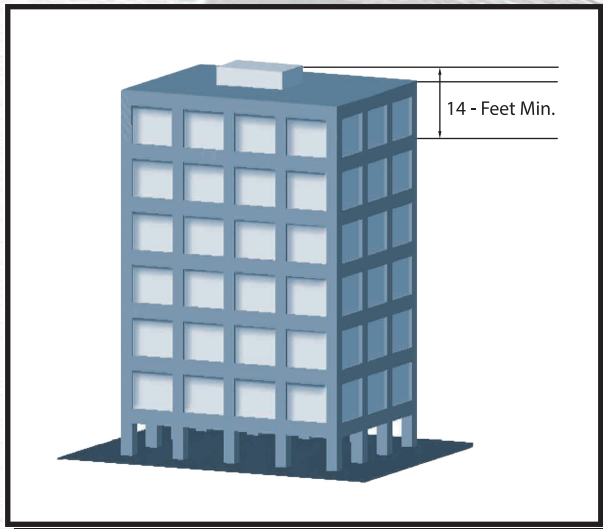

Lift Pit Details:
 (Re-invented Architectural Engineering Efficiency)
 Depth = 1350 mm - 1500 mm
 (depending upon lifts speed)
 Pit must be furnished with Waterproof Concrete
 Fit floor design must be Static load of 5 tons & Dynamic load of 15 tons

MRL Lift:
 (Machine Room Less Lift Overload)
 Machine room not required. Space saving & good looking
 Being gearless lift, requires no gear oil for motor, Engineered with critical components of global standards.

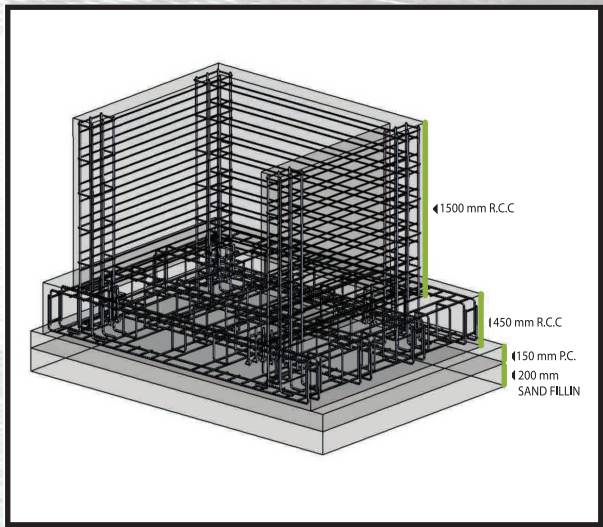

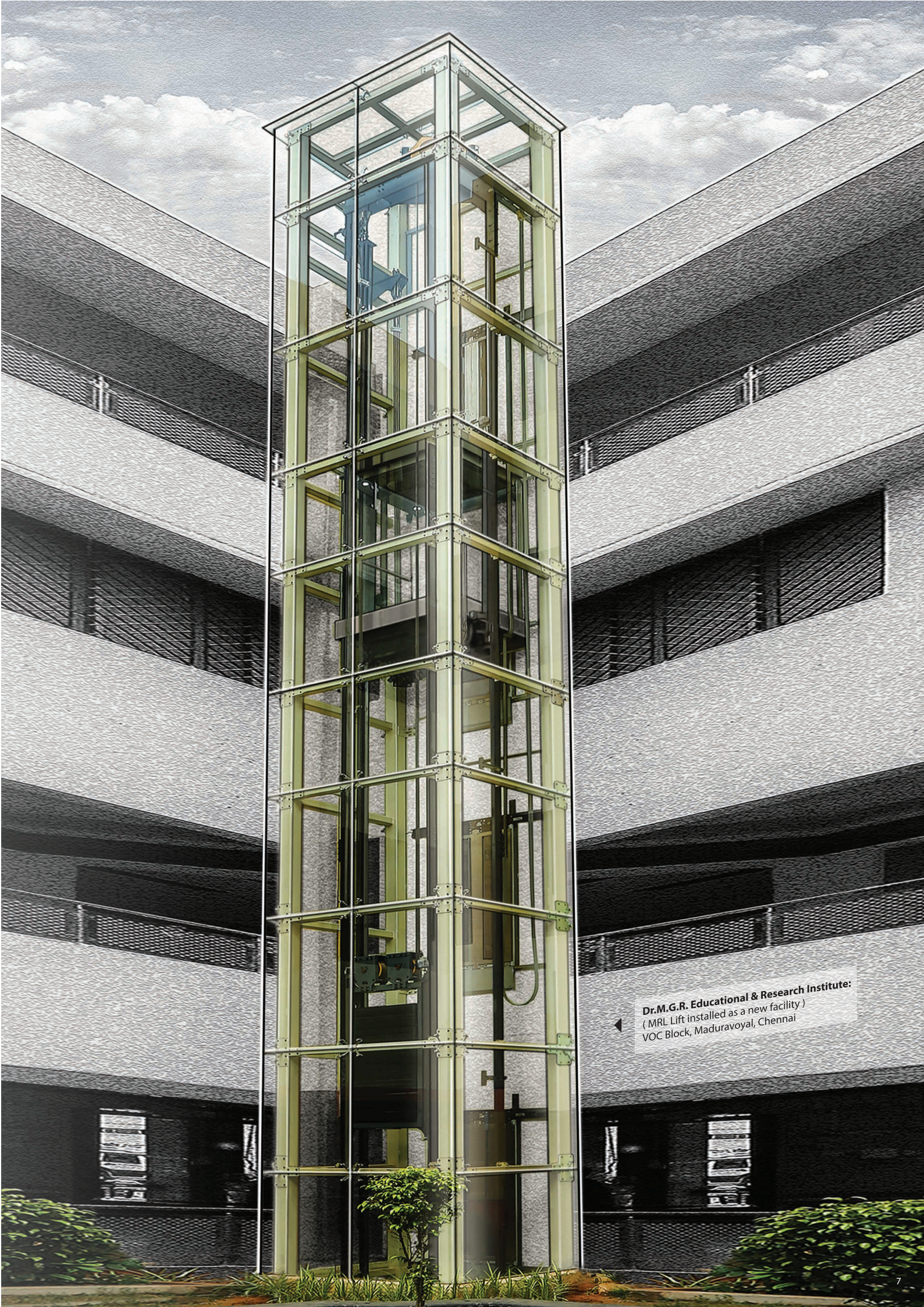

◀ **Dr.M.G.R. Educational & Research Institute:**
(MRL Lift installed as a new facility)
VOC Block, Maduravoyal, Chennai

Glass Lift



Installed at Mr. Ramamoorthy's House, Garudarcharpalya, near NIDHI Bakery, Bangalore

Full Glass Door



Installed at DATA Udipi, Saidapet, Chennai

Hydraulic Lift



Installed at Karya Space, behind Hotel Woodlands

Scenic Lift at a Marriage Hall



Installed at No:526, CLC Works Road, Chrompet, Chennai

Overhead Details

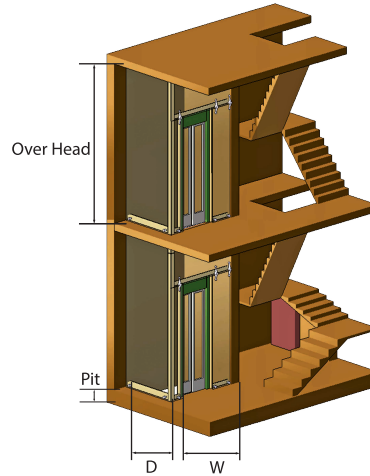
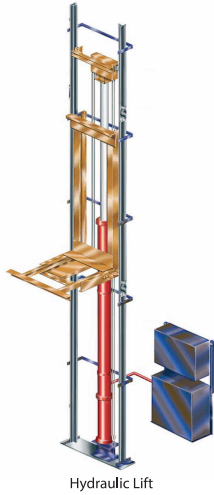
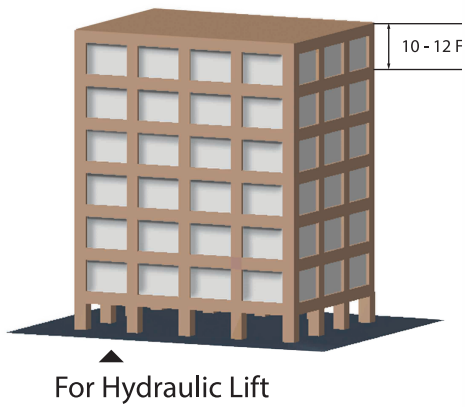

Capacity
 Standard: 404 kgs / 6p
 Special jobs: 200 kgs / 3p

Shaft
 Standard: W1600 mm x D1400 mm
 Special jobs: W1600 mm x D1300 mm

Door
 Standard: W1700 mm x H2000 mm
 Automatic Sliding

Pit
 Standard: 300 mm
 Special jobs: 200 mm

Overhead
 Standard: 3300 mm
 Special jobs: 2900 mm

Speed
 Standard: 0.5 m/s
 Special jobs: 0.2 m/s

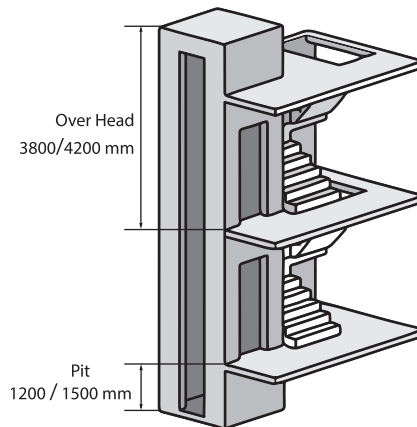
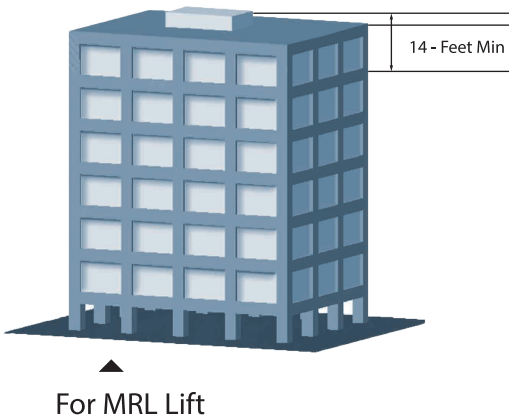

Cooper Classic
 Machine Room Less Lift (MRL)

Capacity
 6, 8, 10, 15 passengers

Speed
 1.0, 1.5, 1.75 m / s

Max. Floors
 30 Floors

Max. Travel
 90 mts

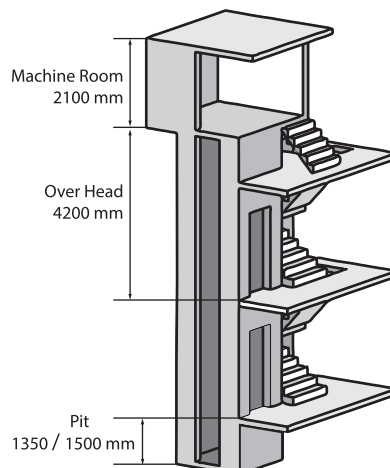
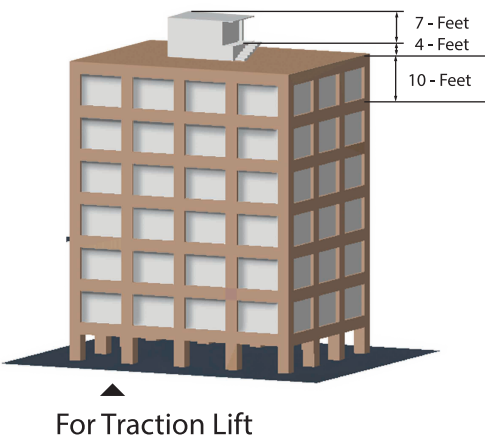

Cooper Standard
 Traction Lift
 (With Machine Room)

Capacity
 4, 6, 8, 10, 15, 20 passengers

Speed
 0.67, 1.0, 1.5, 1.75 m / s

Max. Floors
 36 Floors

Max. Travel
 110 mts

View of our commercial installations

SHOPPING MALL with MULTIPLEXES cum RESIDENTIAL



Patil Planet
B.M. Patil Road, Banjara Cross, near BLDE University, Vijayapura, Bijapur, Karnataka

ORNAMENTS SHOWROOM



Silver Emporium
New No.199, Venkatchala Mudali Street, Mylapore, Chennai

SPECIALITY HOSPITAL & EYE CARE



DRR Hospital
No.399, Trunk Road, Karayanchavadi, Poonamalle, Chennai

EVENTS & ENTERTAINMENT AUDITORIUM



R.R.Sabha
No 30/1, Sundareswarar Street, Mylapore, Near Sivaswamy School, Chennai



Tanishq
No.407/27A, GST Road, Chromepet, Chennai



Tanishq
No.185, Devi Karumari Amman Nagar, Valasaravakkam, Chennai

Your one-stop solution - Cooper

Whatever the size, application or technical constraints that one may have with your projects, Cooper has the perfect solution for you! Choose Cooper, Choose Convenience, Comfort & Performance!

Cooper Elevators India Pvt. Ltd.

Corporate Office:

CHENNAI No:3 / 533, Bell Nagar, Madhanandapuram, Kundrathur Main Road, Porur, Chennai, Tamil Nadu – 600 116 mobile: +91 9344 05 22 08 email : presales@cooperelevators.com

Branch Office:

COIMBATORE No. 90, Sree Nagar, Hope College, Peelamedu Coimbatore, Tamil Nadu – 641 004 mobile: +91 9344 05 22 07 email: coimbatore@cooperelevators.com

TRICHY No. 1, Vinayaga Nagar, 4th Street, Karumandapam, Trichy, Tamil Nadu – 620 001 mobile: +91 91235 46722 email: trichy@cooperelevators.com

BANGALORE No. 402/1/1, First Floor, 22nd Cross Street, 25th Main Road, HSR Layout 2nd Sector, Bangalore, Karnataka – 560 102 mobile: +91 810 516 2224 email: bangalore@cooperelevators.com

VIJAYAWADA No. 31-23-30, Machavaram Down, Eluru Road, Vijayawada, Andhra Pradesh – 520 004, mobile: +91 9791074242 email: vijayawada@cooperelevators.com

PUNE, MYSORE, HYDERABAD Mobile: +91 9840011352

www.cooperelevators.com

